

# MTPReel™

## STÄUBLI

sumcab  
ROBOTICS

The automatic cable retraction system  
for improved workplace safety

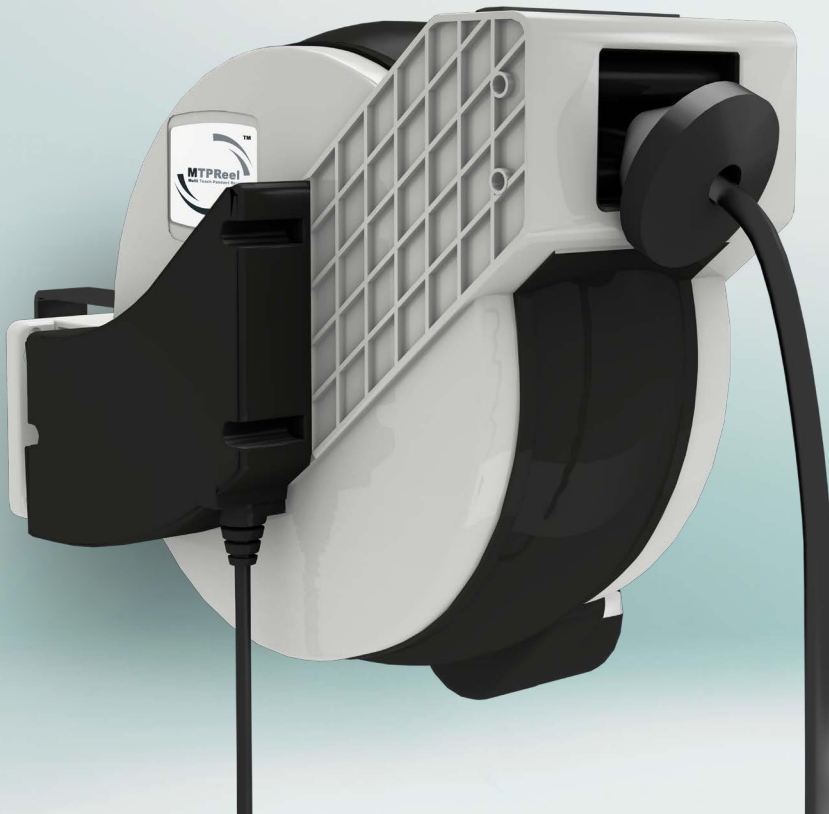

### Time saving

Time is an essential success factor within the industrial sector and the MTPReel helps to save time due to its intuitive operation. The rapid but careful rewinding of the connector cable saves time, which your employees can dedicate to other things.



### Operating error avoidance

Using the MTPReel will ensure that the operating device is assigned unambiguously to the operator. Lengthy searches for the correct plug-in piece and potential operating errors due to incorrect combinations are avoided.



### Plant safety optimisation

Properly storing the connector cable in the MTPReel protects it from dirt and accidental damage, which significantly increases its service life and improves safety within the operational facility.



### Patented and tested system – made in Italy

Our partner company in Italy manufactures the MTPReel to the highest quality standards.









### Safety First

Hazardous situations, such as trip hazards or cable damage, are now a thing of the past.



## Technical specifications

|  Robot control |  Box size |  Extension length |  Cabinet connection |  Dimensions (mm) |  Weight (kg) |
|---|--|--|--|---|---|
| SP1   | MTPReel - 0  | Bis max. 20 m  | 2,5 m / 4,0 m  | 434x227x384   | 4,5kg   |
| SP2   | MTPReel - 0  | Bis max. 20 m  | 2,5 m / 4,0 m  | 434x227x384   | 4,5kg   |

Additional housing sizes, cable lengths, and control generations available upon request.

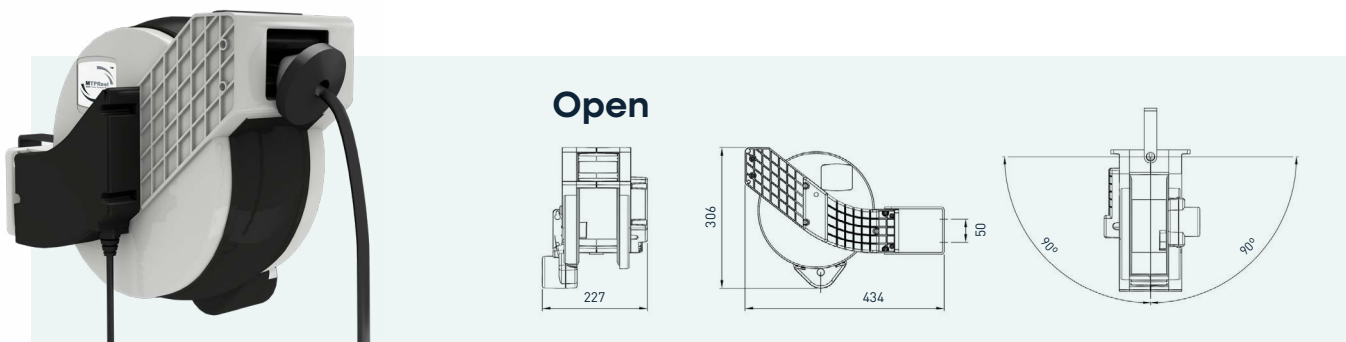

### + Extras

- Housing made of shock-resistant material
- Stable, rotatable mounting bracket
- Integrated brake module for a careful cable retraction
- Spring loaded cable retraction system
- Detachable automatic cable release and retraction brake every 50 cm
- Rotating contact transmission system for secure data transmission

### + Accessories

#### Installation element

- Profile tube stands (rigid or rotatable)
- Control cabinet fixing plates, aluminium profiles or fence elements

#### Connection and extension cables

- 10 m and 20 m connection cables available for all MTPReels
- 10 m, 15 m and 20 m extension cables available for all MTPReels



Follow us

